

9M. POLYGONAL HOT DIP GALVANIZED POLE

Without Cross Arm

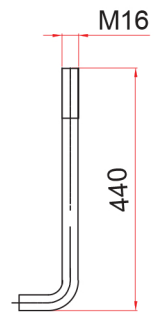

4 X M16 x 500 Anchor Bolts

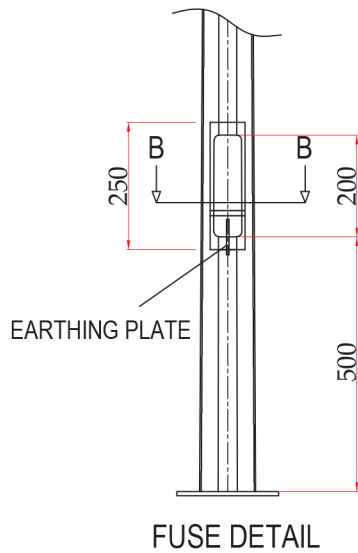
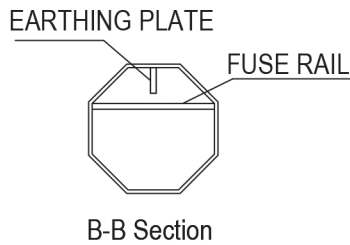
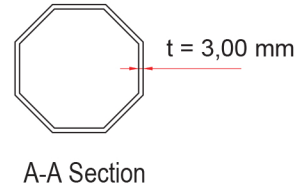
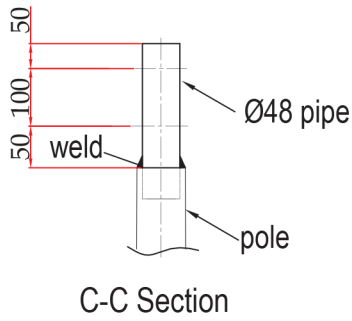
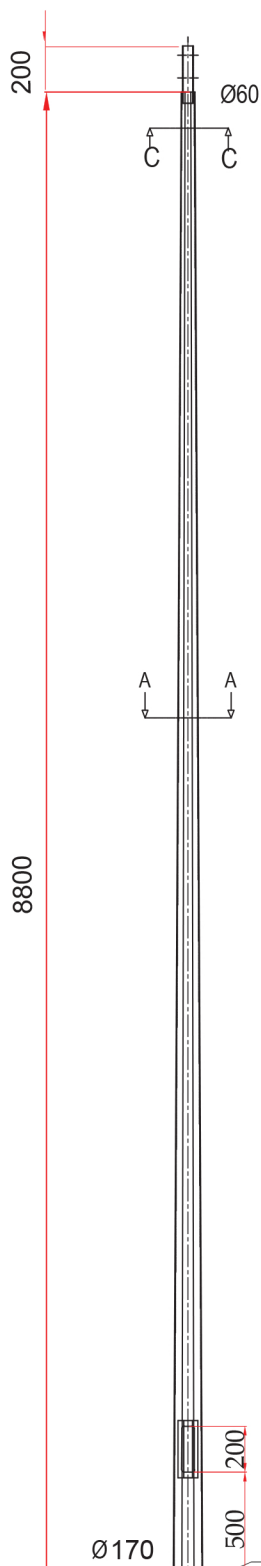
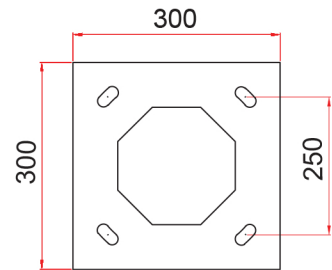

BASE PLATE

12mm x 300 x 300

600x600x800mm

All dimensions mm.



Plate Standard : EN 10025
 Production Standard : EN 40-5
 Galvanizing Standard : EN 1461

ST-O.9M.BASIC

without Cross Arm

Steel : S235JR (ST37)

www.spotvisionlighting.ro

Designed according to the dimensions and the specifications with EUROPE NORM.

Rev : 0